

N 103 - 2022. 12



E62

xNew architrave profile

content:

PROFILES

DETAILS

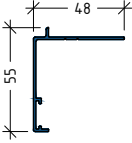
code	 profile	weight length moment of inertia	code	 profile	weight length moment of inertia
E62031 Architrave		400 g/m L=6.01 m			

E62031
Architrave
400 g/m

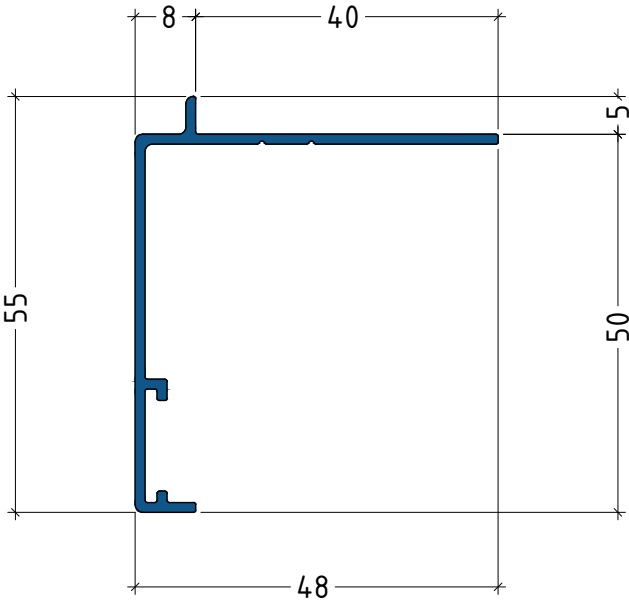

opening systems

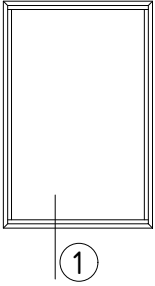

1

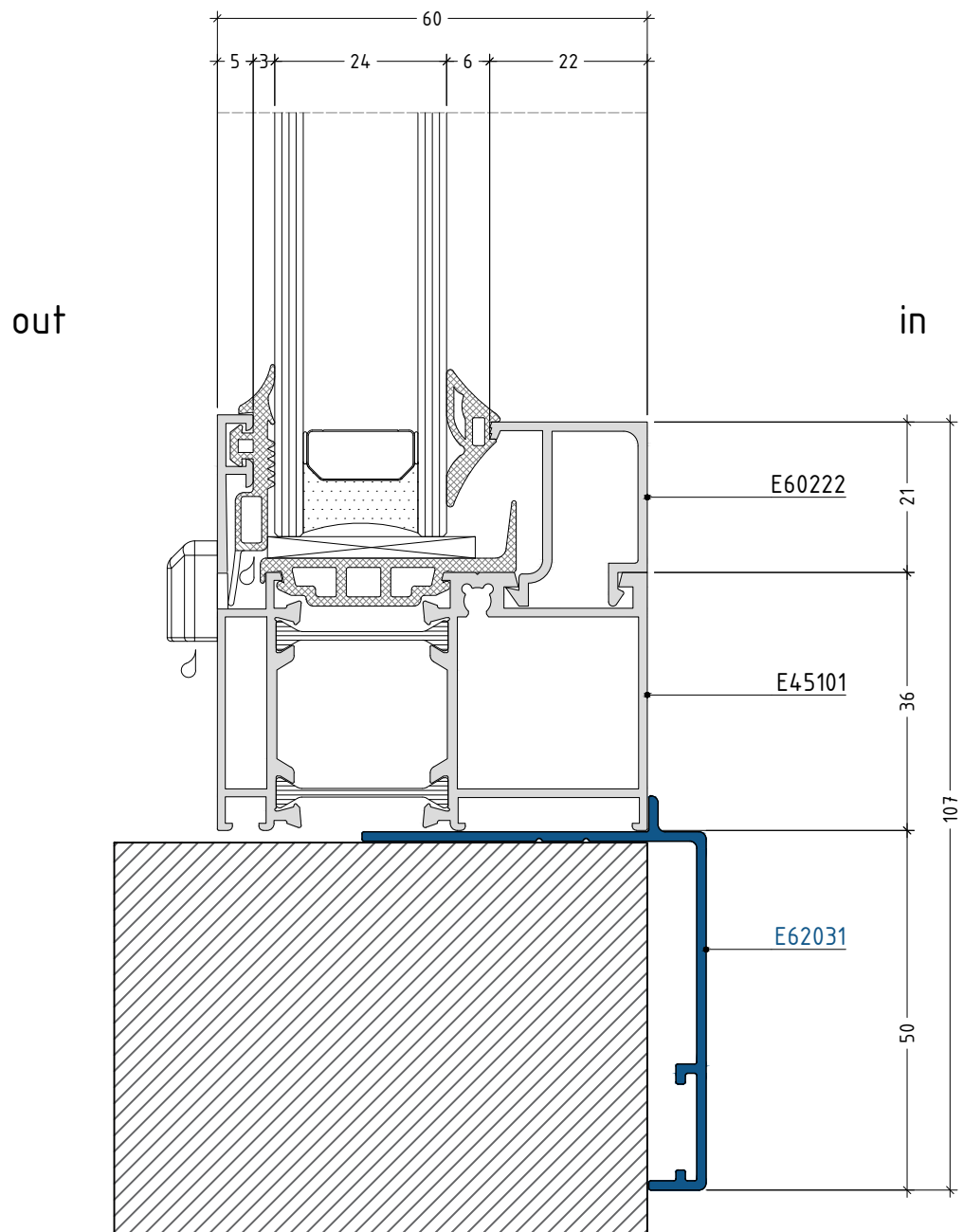

scale 1:1

opening systems

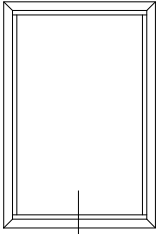

1

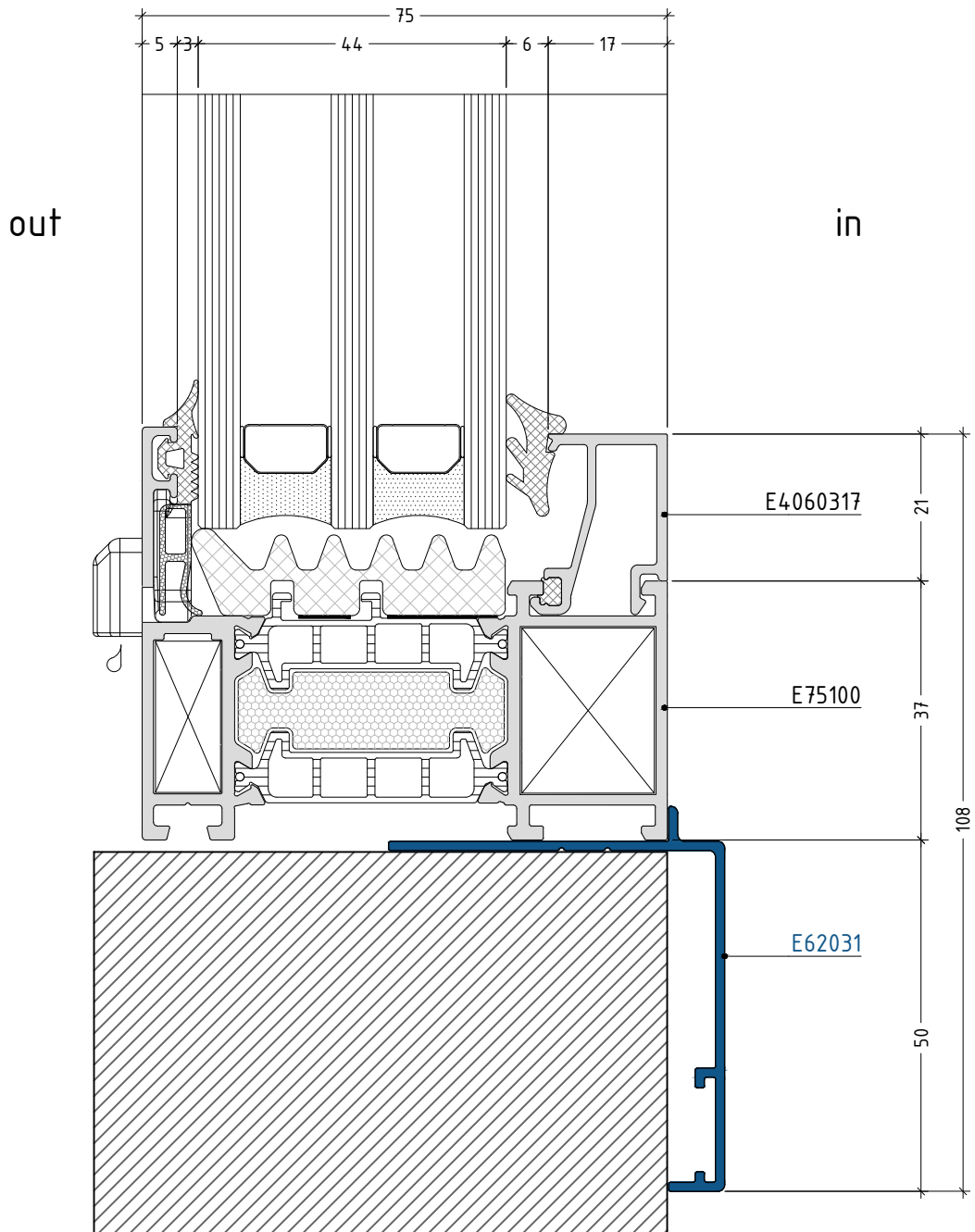

scale 1:1

scale 1:1

1

sliding systems

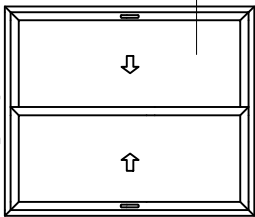

in

out

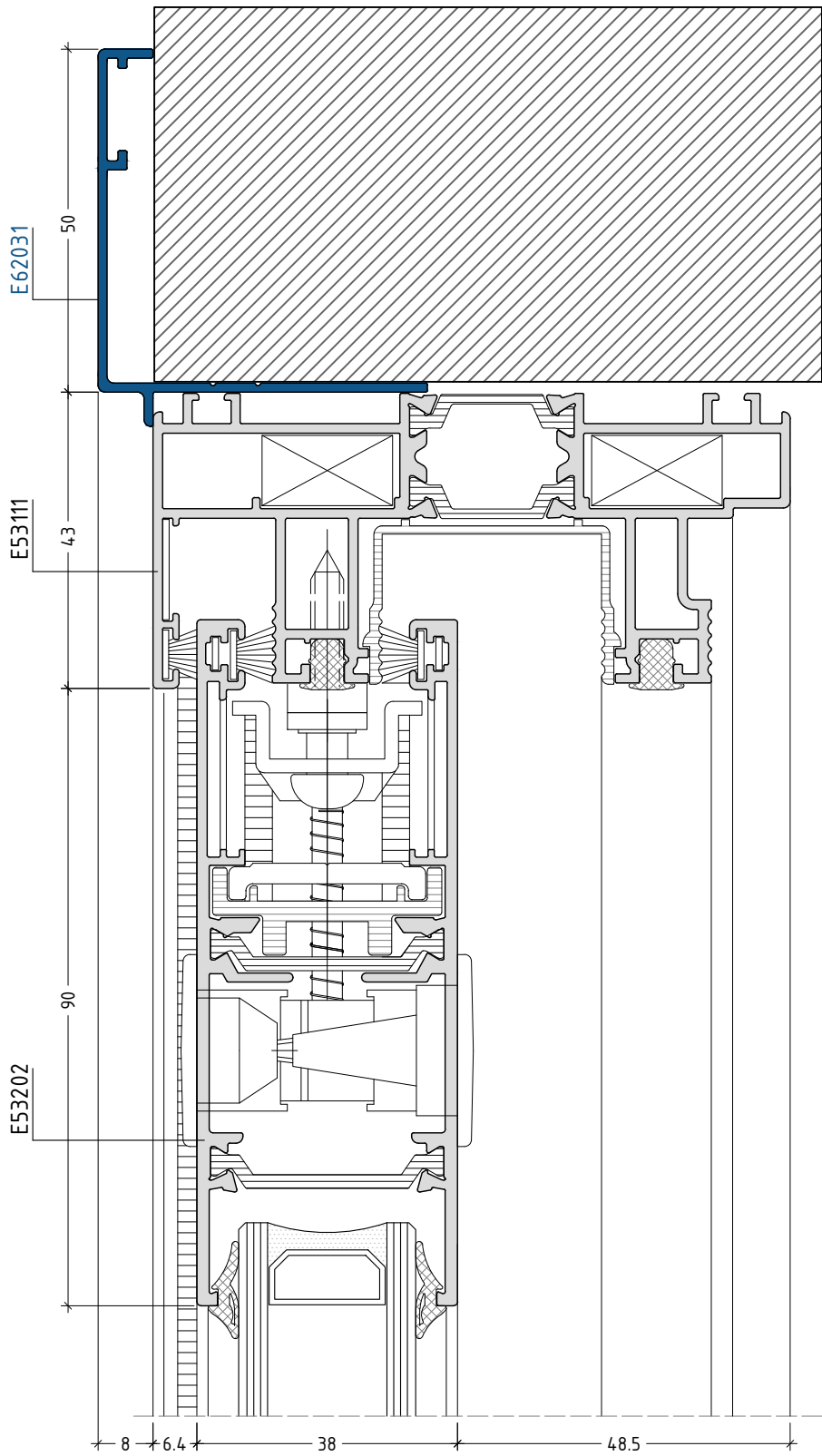

rolling shutter systems

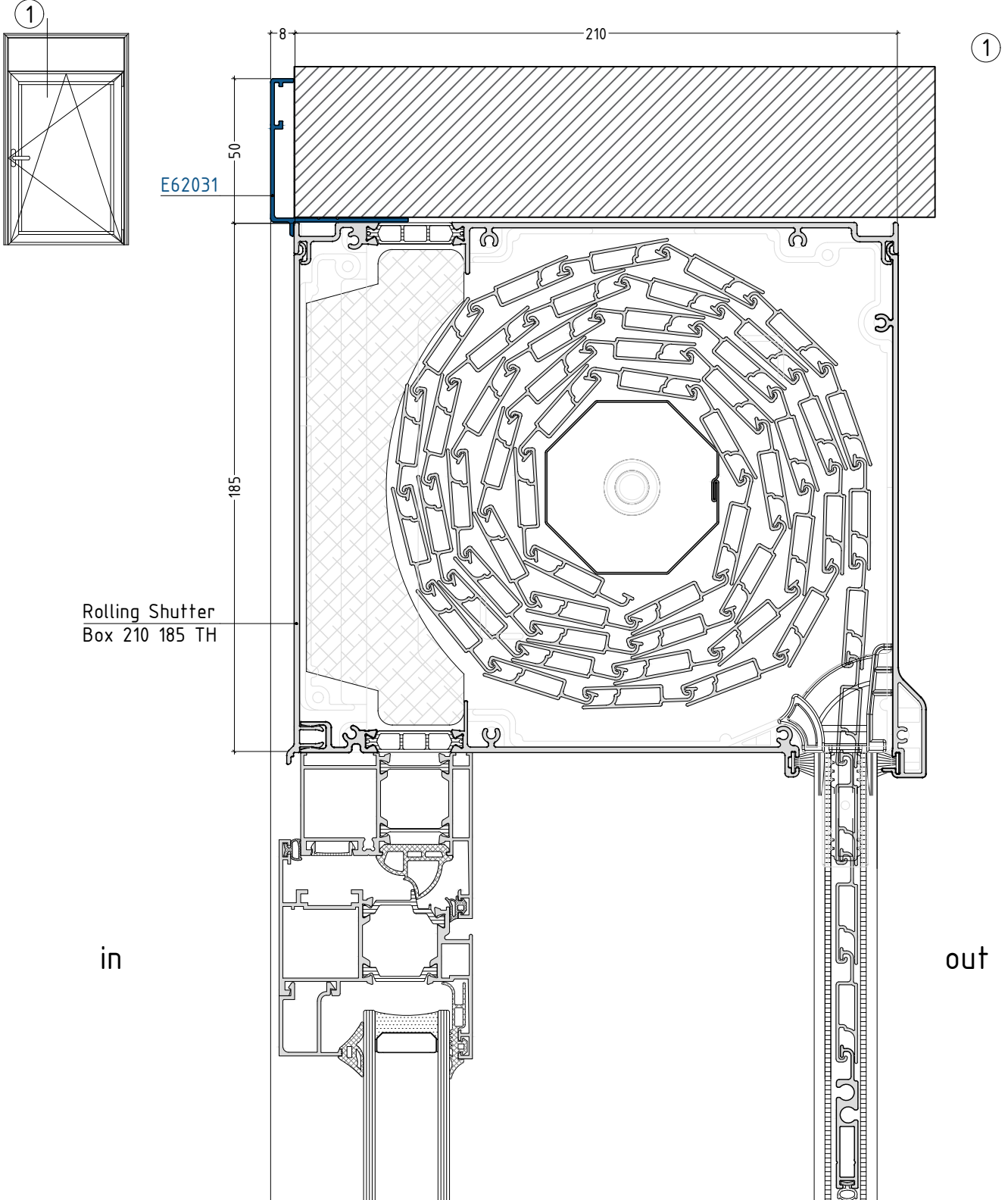

scale 1:2

code/description	package/pcs	colour
ET 056607.00		inox
ET 057705.00		polyamid 6.6

Alignment corner

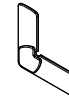

polyamid 6.6

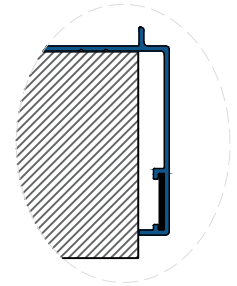

E62031

